

# Metal Trim Details Standard and Custom

**DrexelMetals**  
Roofing Systems + Custom Fabrication

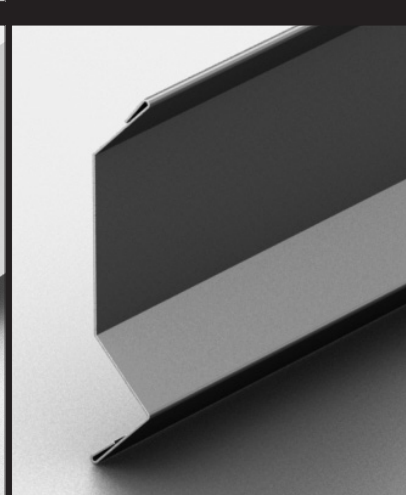

41 N. LAWN AVE  
ELMSFORD, NY 10523  
914-347-8157

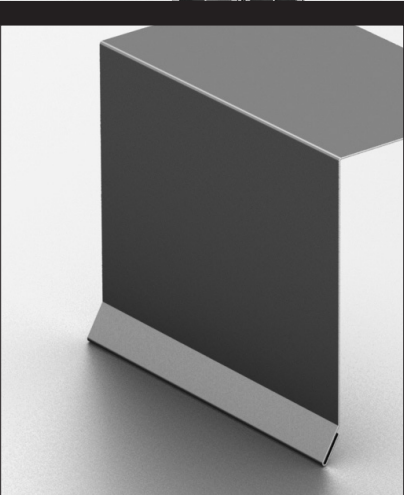
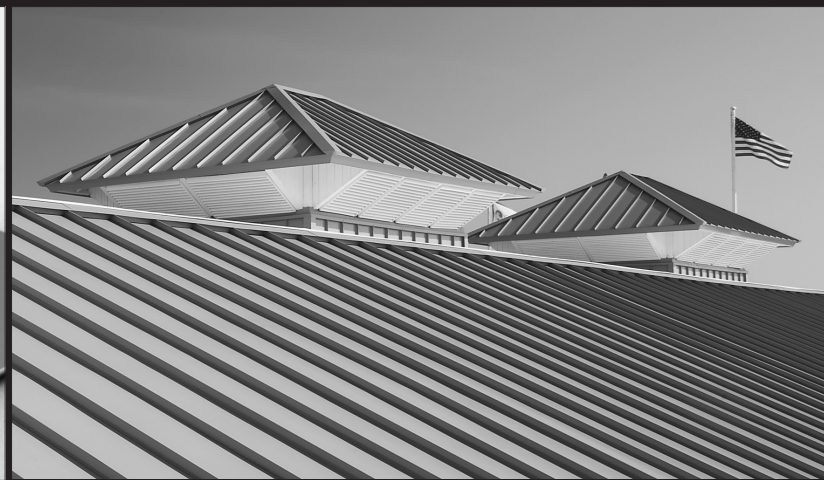

Simplifying Metal Roofing Systems



Architectural • Commercial • Restoration/Custom

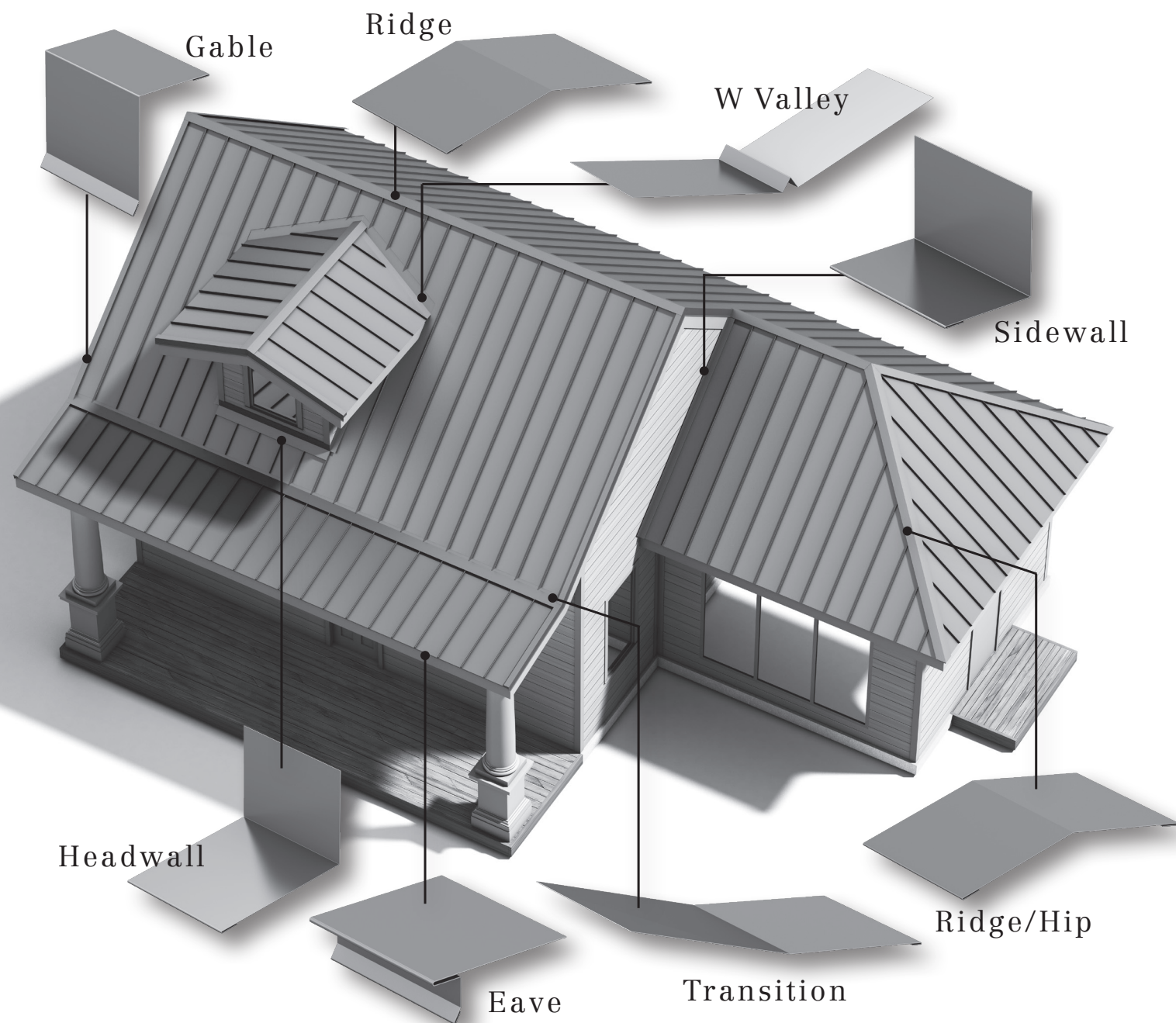

### Project Information:

Project Name: \_\_\_\_\_ Date: \_\_\_\_\_

Customer Name: \_\_\_\_\_ Contact: \_\_\_\_\_

Phone Number: \_\_\_\_\_ Email: \_\_\_\_\_

### Metal Roofing Specifications:

Gauge:  26ga  24ga  22ga Aluminum:  .032  .040

Panel Width: \_\_\_\_\_ Roof Area sq/ft: \_\_\_\_\_ Color: \_\_\_\_\_

### Panel Profile:

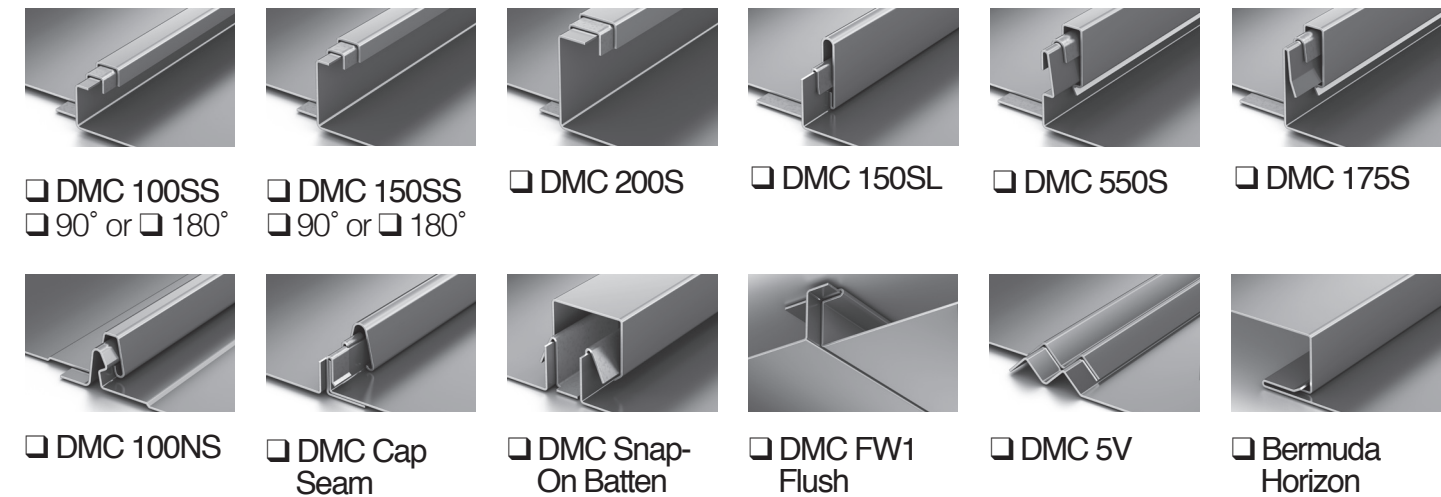

### Panel Rib:

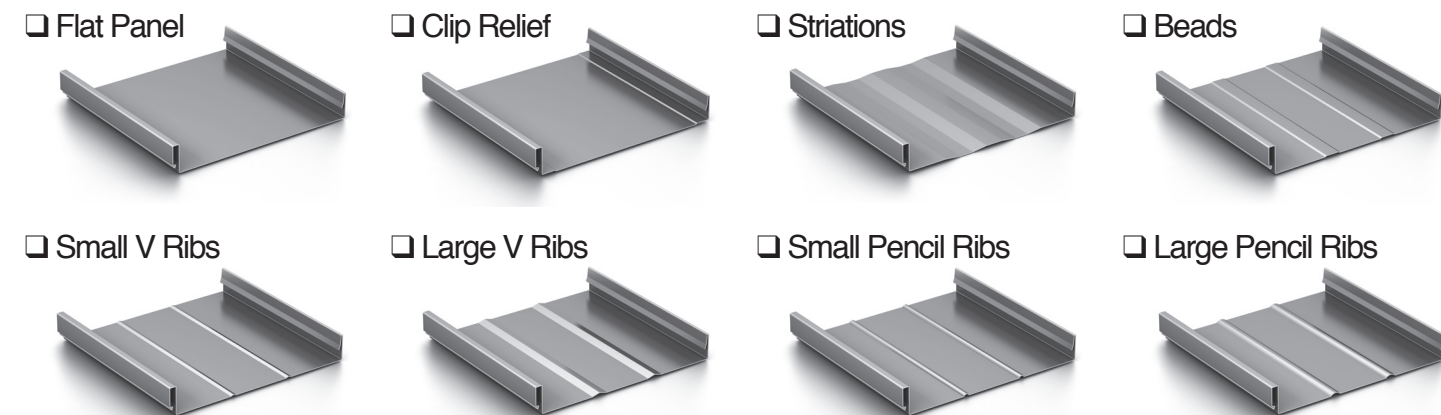





## Eave

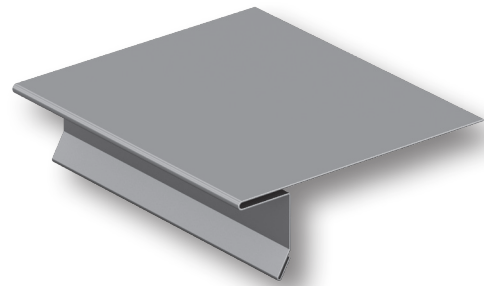

- 10' Length  
Specify Quantity: \_\_\_\_\_
  - 20' Length  
Specify Quantity: \_\_\_\_\_
- Select Roof Pitch  
Specify 1 thru 12: \_\_\_\_\_  
(See Roof Pitch diagram, pg. 4)

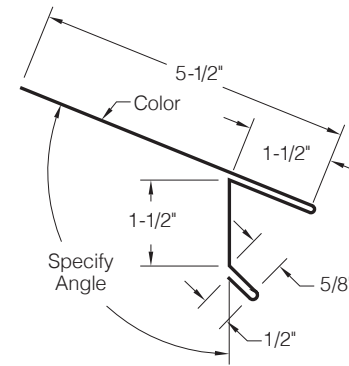

## Ridge / Hip

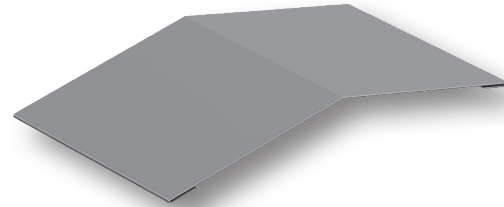

- 10' Length  
Specify Quantity: \_\_\_\_\_
  - 20' Length  
Specify Quantity: \_\_\_\_\_
- Select Roof Pitch  
Specify 1 thru 12: \_\_\_\_\_  
(See Roof Pitch diagram, pg. 4)

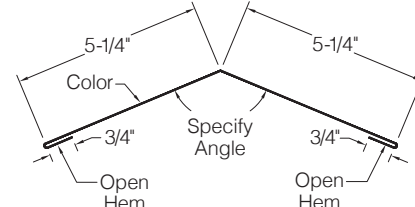

## Rake wall



- 10' Length  
Specify Quantity: \_\_\_\_\_
- 20' Length  
Specify Quantity: \_\_\_\_\_

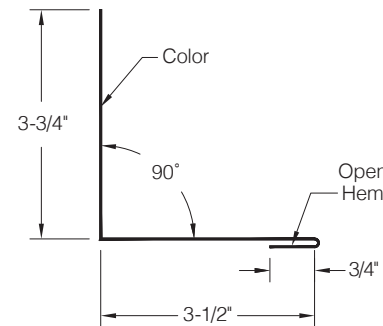

## Head wall

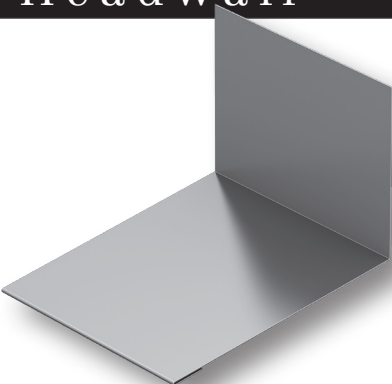

- 10' Length  
Specify Quantity: \_\_\_\_\_
  - 20' Length  
Specify Quantity: \_\_\_\_\_
- Select Roof Pitch  
Specify 1 thru 12: \_\_\_\_\_  
(See Roof Pitch diagram, pg. 4)

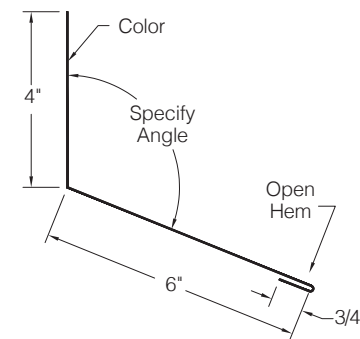

## Gable

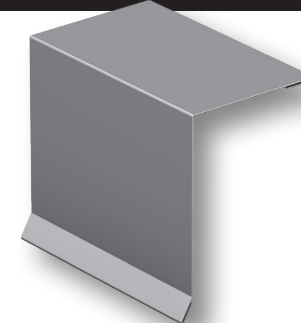

- 10' Length  
Specify Quantity: \_\_\_\_\_
- 20' Length  
Specify Quantity: \_\_\_\_\_

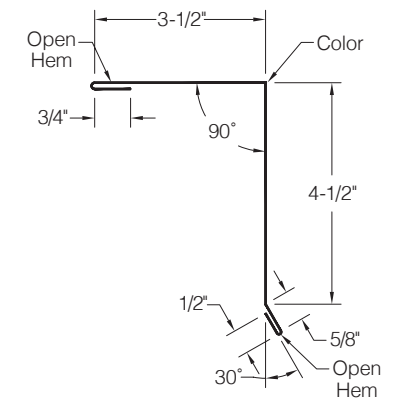

## Pre-Applied Gable

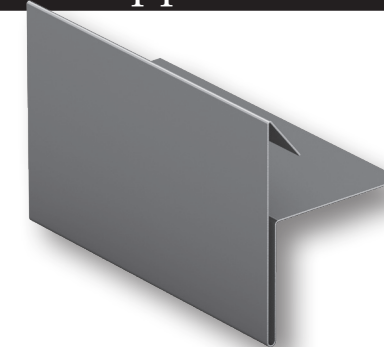

- 10' Length  
Specify Quantity: \_\_\_\_\_
- 20' Length  
Specify Quantity: \_\_\_\_\_

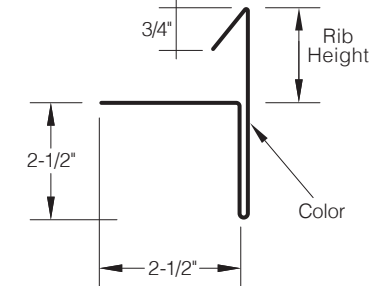

## Zee

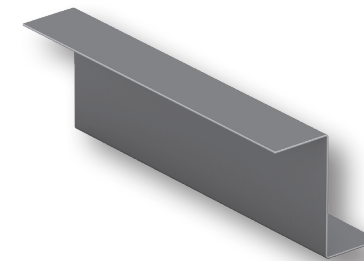

- 10' Length  
Specify Quantity: \_\_\_\_\_

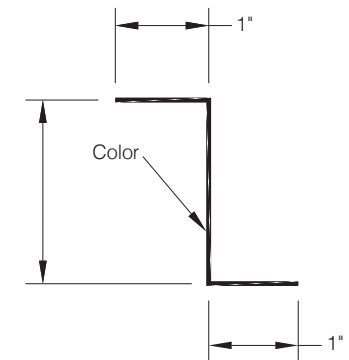

## CFR

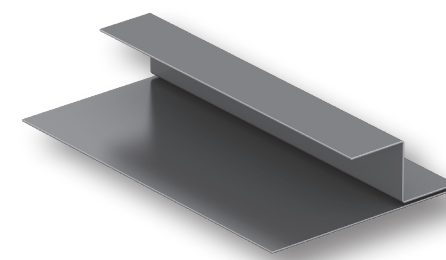

- 10' Length  
Specify Quantity: \_\_\_\_\_
- 20' Length  
Specify Quantity: \_\_\_\_\_

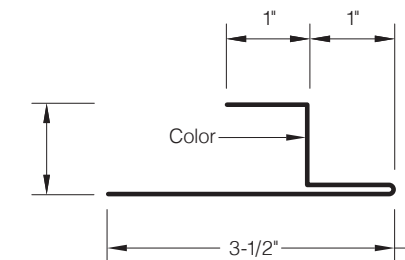



## W Valley

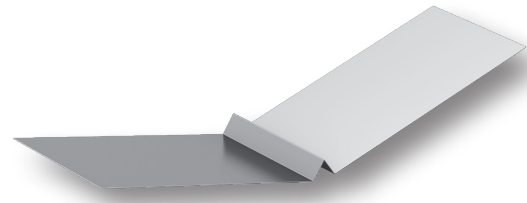

- 10' Length  
Specify Quantity: \_\_\_\_\_
  - 20' Length  
Specify Quantity: \_\_\_\_\_
- Select Roof Pitch  
Specify 1 thru 12: \_\_\_\_\_  
(See Roof Pitch diagram, pg. 4)

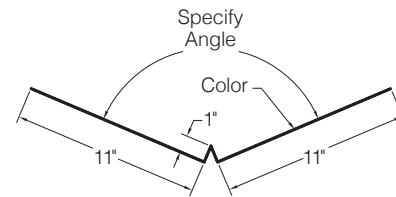

## Offset Cleat

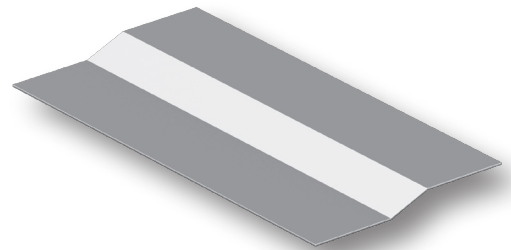

- 10' Length  
Specify Quantity: \_\_\_\_\_

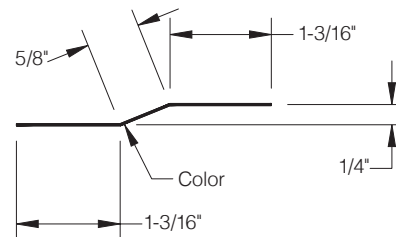

## Transition



- 10' Length  
Specify Quantity: \_\_\_\_\_
  - 20' Length  
Specify Quantity: \_\_\_\_\_
- Select Roof Pitch: Specify 1 thru 12:  
Upper Pitch (9-1/4"): \_\_\_\_\_ Lower Pitch (6"): \_\_\_\_\_  
(See Roof Pitch diagram, pg. 4)

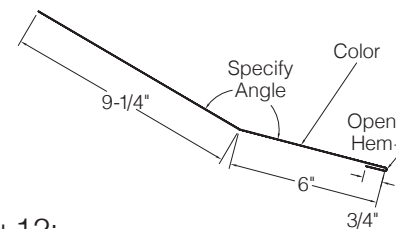

## Peak

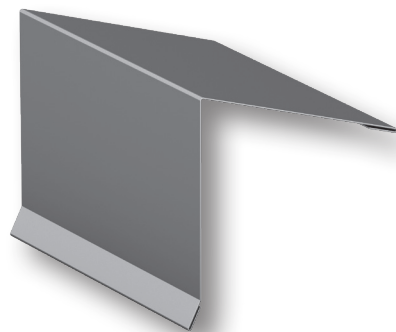

- 10' Length  
Specify Quantity: \_\_\_\_\_
  - 20' Length  
Specify Quantity: \_\_\_\_\_
- Select Roof Pitch  
Specify 1 thru 12: \_\_\_\_\_  
(See Roof Pitch diagram, pg. 4)

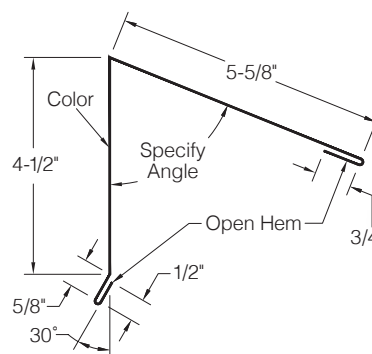

## Vented Ridge

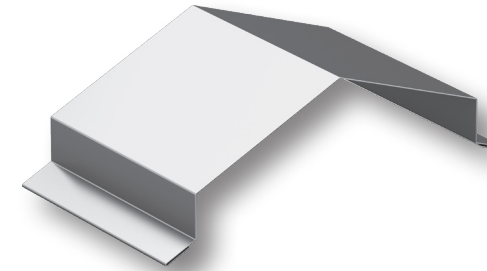

- 10' Length  
Specify Quantity: \_\_\_\_\_
  - 20' Length  
Specify Quantity: \_\_\_\_\_
- Select Roof Pitch  
Specify 1 thru 12: \_\_\_\_\_  
(See Roof Pitch diagram, pg. 4)

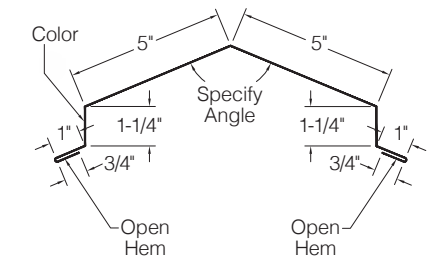

## Vented Zee

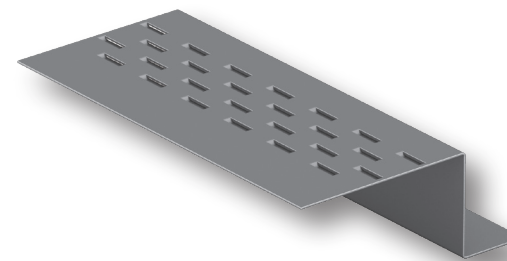

- 10' Length  
Specify Quantity: \_\_\_\_\_

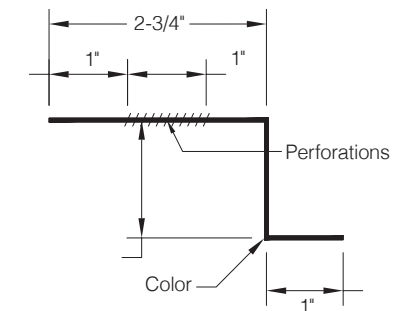

## Counter Flashing

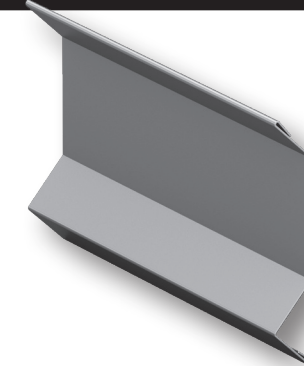

- 10' Length  
Specify Quantity: \_\_\_\_\_
- 20' Length (check)  
Specify Quantity: \_\_\_\_\_

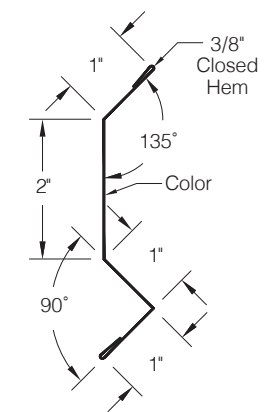

## Reglet

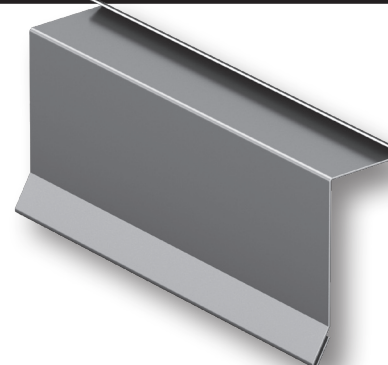

- 10' Length  
Specify Quantity: \_\_\_\_\_
- 20' Length (check)  
Specify Quantity: \_\_\_\_\_

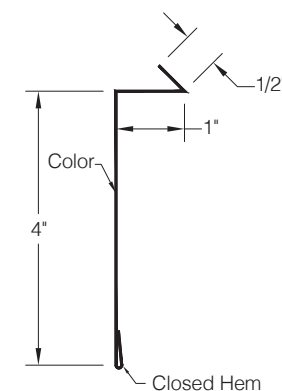





# Drexel Metals Roofing Systems

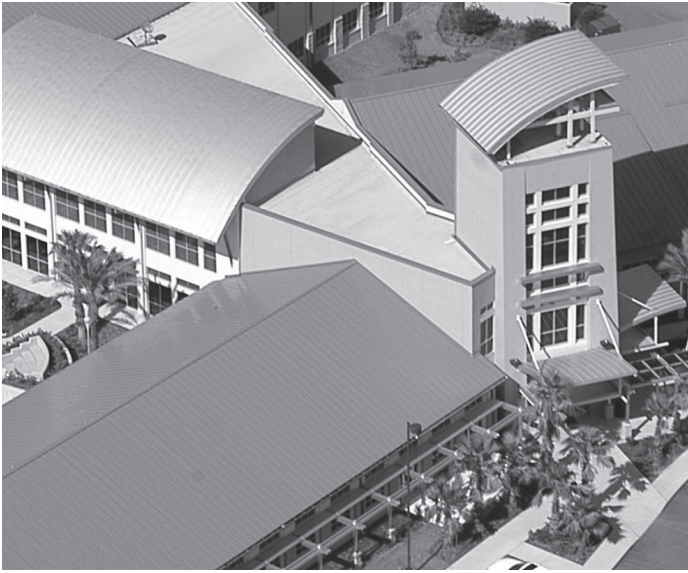

**Drexel Metals**   
Roofing Systems + Custom Fabrication



**TRI-STATE  
METALS**  
LLC

41 N. LAWN AVE  
ELMSFORD, NY 10523  
914-347-8157